



## **ASSEMBLY INSTRUCTION**

ITEM#: H21GT722VS

SKU#: 810554528

---

# **SANDPOINTE SIDE TABLE**

---

**Need help? We are here for you! 1(877) 800-6021 • Toll Free**

**service@hccipatio.com • Email Address**

---

---

# GENERAL BEST PRACTICES FOR ASSEMBLY:

---

---

To Ensure Alignment & Easy Assembly, Secure All Bolts & Washers In Place Before Fully Tightening

Read all instructions before starting

Clear a flat covered space to begin assembly

Always best to do it with a friend

Note that hardware required is provided for every step

Pay attention to orientation

Letter of the part corresponds to a sticker on the product

Number of the hardware corresponds to its letter in the package

Helpful hints provided along the way

Retain these assembly instructions for future reference

---

---

## WARNINGS:

---

---

Regularly check hardware and tighten if necessary

Use the correct bolts as indicated. Do not tighten any of the bolts until the table is completely assembled.

Do not sit or stand on this table.

Do not discard of any of the packaging until you have checked that you have all of the parts and fittings required.

Keep children away during assembly. This item contains small parts that can be swallowed by children.

Children should always be under direct adult supervision while using this product.

Table is not to be used as a seating surface. Improper use of this product or failure to use may result in injury.

Do not place hot objects over 80 degrees on surface. Do not allow glasses to stand on the table surface under the sun for a long time to avoid damage caused by high temperatures. Do not use abrasives or sharp tools when cleaning surface.

---

---

## MAINTENANCE:

---

---

Wash frame parts with mild soap and water, rinse thoroughly, and dry completely. Do not use bleach, acid, or other solvents on the frame parts.



Inspect and tighten all bolts and fasteners on a regular basis to ensure the proper performance and safety of your table.



When moving the table, lift. Do not drag this table.

We recommend the use of furniture covers when not in use.

In order to prolong the life and beauty of your table, we recommend that it be stored in a dry and protected area during off season periods.

PARTS LIST

PART NO.	MATERIAL CODE	PART	Q'TY
1	H21GT722VS-ZM	 TABLE TOP	1
2	H21GT722VS-JG	 LEG	2
3	H21GT722VS-ZJ	 CENTER CONNECTOR	1

PART NO.	MATERIAL CODE	PART	Q'TY
4	LS-M6-15	 BOLT M6*15	8
5	LS-M6-30	 BOLT M6*30	4
6	DP-d6.5-D13	 WASHER d6.5*D13*1.0	12

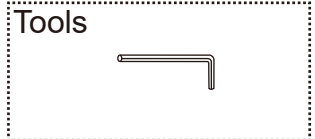

STEP 1

PARTS REQUIRED: 1, 2, 4, & 6  
Keep the bolts loose.

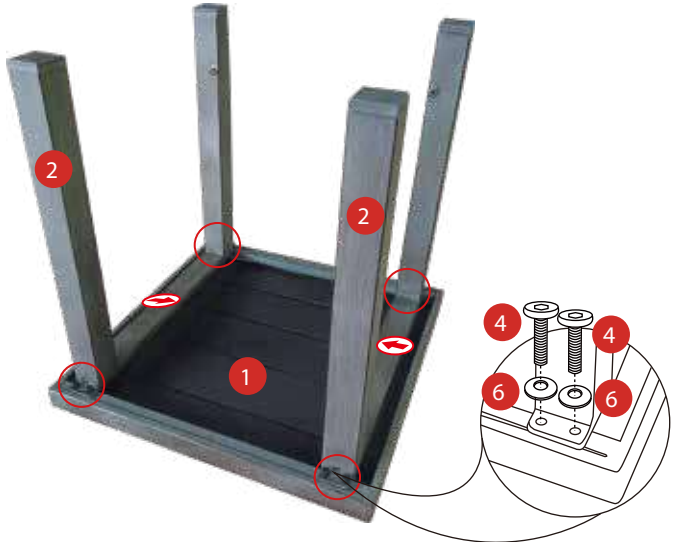
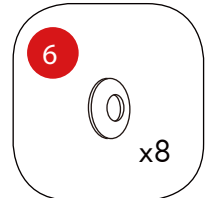
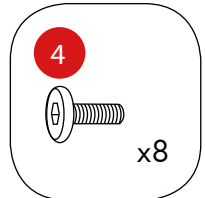

Note:  
The arrows marks on the legs (#2) should coincide with Figure 1 to ensure proper assembly.

---

---

## STEP 2

---

---

PARTS REQUIRED: 2, 3, 5, & 6

Tighten all bolts by using the supplied Hex key.

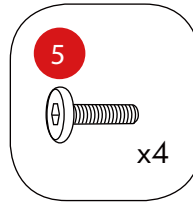
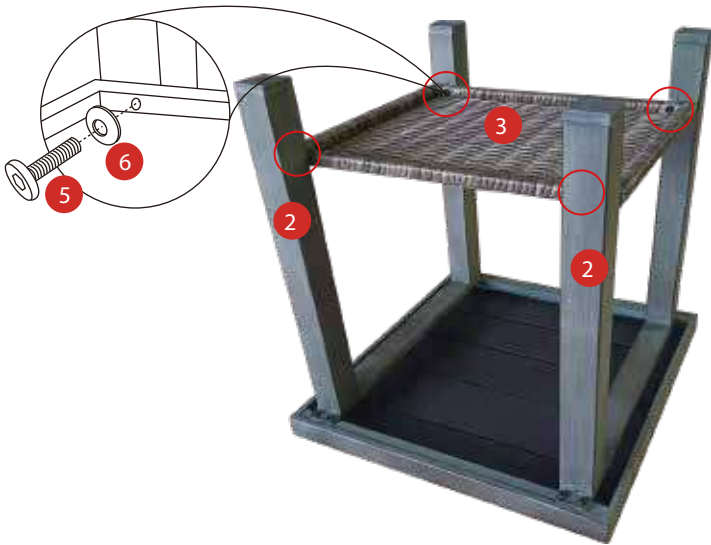

---

---

## STEP 3

---

---



### Warranty

- One-year limited warranty.
- Proof of purchase (dated register receipt) is required for warranty claims.
- It remains the customer's responsibility for freight and packing charges to and from the service center.

# STOP!

## Missing A Part? No Need To Go Back To The Store

The store where you made your purchase does not stock parts for this item.  
If you need parts, whether they are missing or damaged,

Call Toll Free:

TEL: 1(877) 800-6021

Call us between 9:00 AM and 4:30 PM Eastern Time Monday through Friday  
For further assistance, please visit us at [service@hcupatio.com](mailto:service@hcupatio.com)